

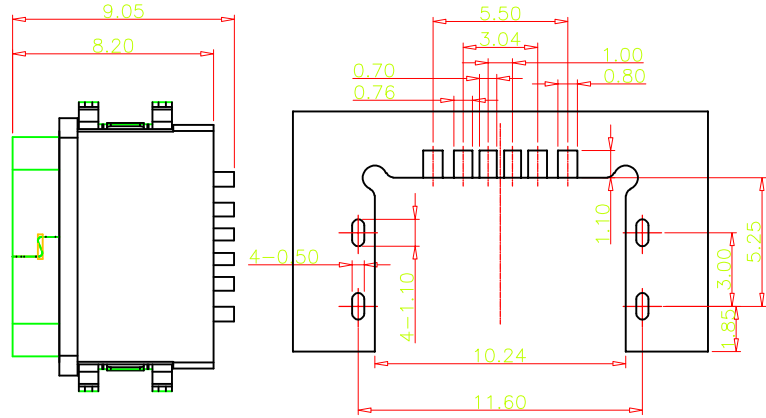

| REV. | ECN NO. | DESCRIPTION | DRAW | APPD. | DATE |
|------|---------|-------------|------|-------|------------|
| A | --- | 新版本发行 | | | 2018.11.05 |

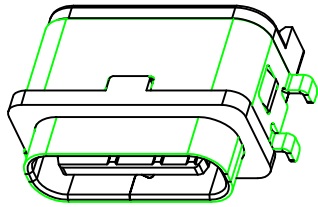

- NOTES:
SPECIFICATION:
- CURRENT RATING: 3.0A MAX
 - VOLTAGE: 100 VAC
 - TEMPERATURE RANGE: -30 °C ~ 85 °C
 - CONTACT RESISTANCE: 40 MILLIONHM MAX
 - INSULATION RESISTANCE: 100 MEGOHMS MIN.
 - INSERTION FORCE : 5N~20N
 - UNMATING FORCE: 8N~20N
 - DURABILITY: 10,000 CYCLES
 - WATER PROOFNESS: THIS PRODUCT IS BASED ON IPX7.

RECOMMENDED P.C.B. LAYOUT
TOLERANCE UNSPECIFIED ±0.05mm

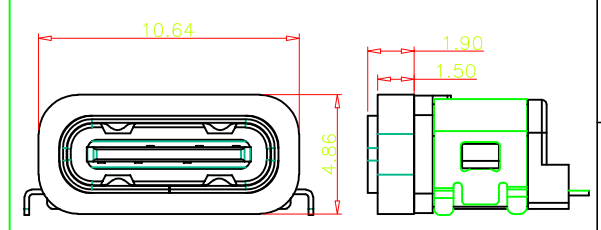
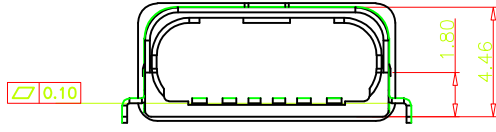
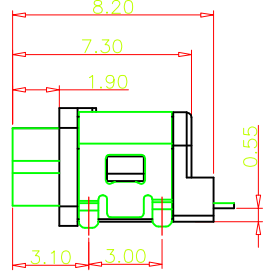
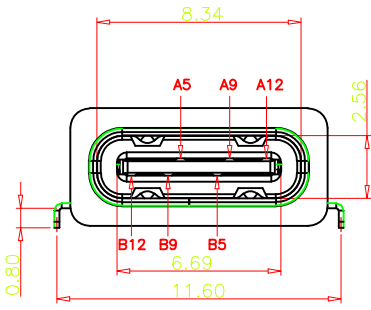

加防水圈示意图

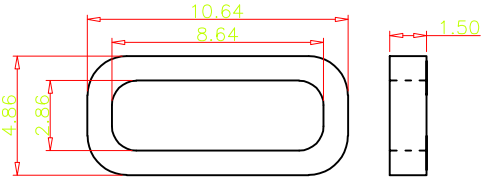

建议的胶圈尺寸

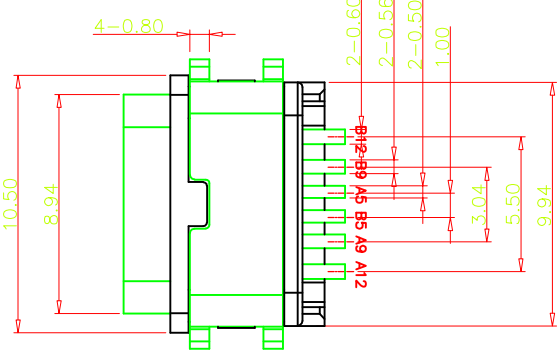

| | | | | |
|-----|-----------------|--------------------------|------------------|------|
| 5 | SHELL | STAINLESS STEEL | NI Plated | 1PCS |
| 4 | SHIELDING PLATE | STAINLESS STEEL | NI Plated | 1PCS |
| 3 | CONTACT | COPPER ALLOY | TIN/Au/NI Plated | 1SET |
| 2 | SHELL HOUSING | HIGH TEMPERATURE PLASTIC | BLACK | 1PCS |
| 1 | HOUSING | HIGH TEMPERATURE PLASTIC | BLACK | 1PCS |
| NO. | DESCRIPTION | MATERIAL | REMARKS | QTY |

| | | | |
|-----|-------------|-----|-------------|
| A5 | CC1 | B12 | GND |
| A9 | VBUS | B9 | VBUS |
| A12 | GND | B5 | CC2 |
| PIN | SIGNAL NAME | PIN | SIGNAL NAME |

| | | | | | |
|-----------|-------|---|-------|---|--|
| TOLERANCE | | NAME (INTENDED USE) CUSTOMER DRAWING | | 东莞市溪榜电子有限公司 DONG GUAN XI BANG ELECTRONIC CO., LTD. | |
| X.X | ±0.30 | X.* | ± 2° | PART NO. | |
| .XX | ±0.20 | .X* | ± 1° | TITLE: C F 单排沉板6P四脚插板防水型母座 | |
| .XXX | ±0.10 | .XX* | ±0.5° | DRAWG NO. XB-AA0-076 | |
| UNITS | mm | APPD: | DMX | SCALE | |
| MATERIAL | | CHED: | TANG | SHEET | |
| FINISH | | DRAW: | SHI | REV. | |
| | | | | 1:1 | |
| | | | | 1/1 | |
| | | | | A | |

| | | | | | |
|------|---------|-------------|------|-------|------------|
| REV. | ECN NO. | DESCRIPTION | DRAW | APPD. | DATE |
| A | --- | 新版本发行 | | | 2018.11.05 |

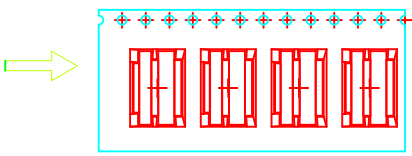
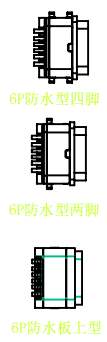

① 产品入载带示意图

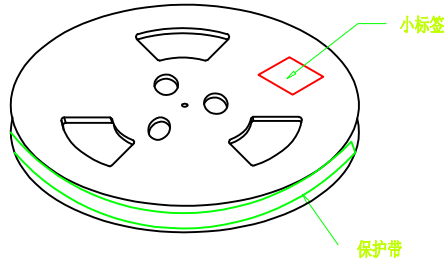

② 卷盘贴标签示意图

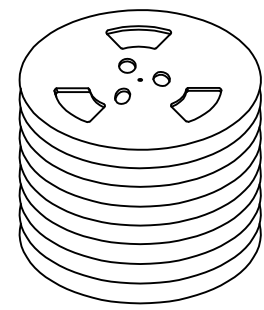

③ 10盘产品叠层示意图

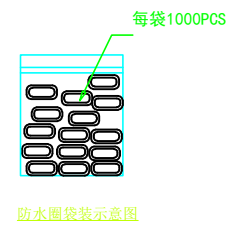

防水圈袋装示意图

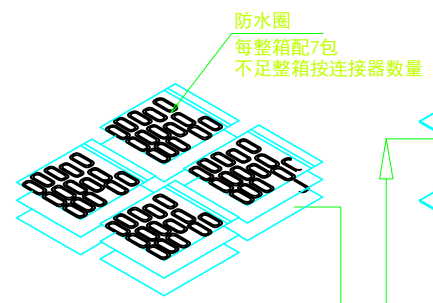

④ 产品入外箱示意图

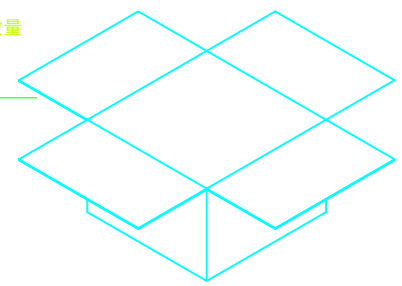

⑤ 外箱封箱示意图

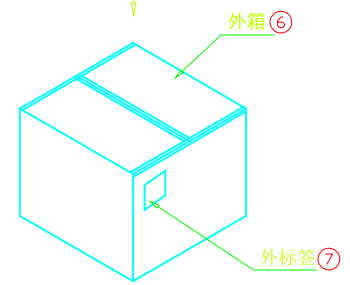

外箱⑥

外标签⑦

NOTE:
 1. QUANTITY/REEL: 700 PCS
 数量/卷: 700 PCS
 QUANTITY/INNER CARTON: 700 X 10 = 7000 PCS
 数量/箱: 700 X 10 = 7000 PCS
 2. FREE 16 CAVE IN THE FRONT CARRIER ADN FREE 16 CAVE IN THE END CARRIER.
 包装带内圈空16格, 外圈空16格.

| | | | | |
|------|--------------|----------|---------------------|------|
| 1 | 成品 | | C F6P防水型沉板母座成品 | 8000 |
| 2 | CARRIER TAPE | PET | W=24mm T=0.35mm | —— |
| 3 | COVER TAPE | PET | W=13.3mm T=0.05mm | —— |
| 4 | 小标签 | | L102mm*W59mm | 10 |
| 5 | 卷盘 | PS | φ330MM*W28.5MM | 10 |
| 6 | 外标签 | | L102mm*W102mm | 1 |
| 7 | 外箱 | A=A | L330mm*W330mm*320mm | 1 |
| ITEM | DESC. | MATERIAL | REMARKS | QTY |

| | | | | | | | |
|-----------|-------|--------------------|-------|------------------|--|--|--|
| TOLERANCE | | NAME(INTENDED USE) | | CUSTOMER DRAWING | | XG 东莞市溪榜电子有限公司 DONG GUAN XI BANG ELECTRONIC CO., LTD. | |
| X.X | ±0.30 | X.* | ± 2* | PART NO. | | TITLE: | |
| .XX | ±0.20 | .X* | ± 1* | | | TYPE C F沉板6PIN 沉板插板防水型母座 一包装规范 | |
| .XXX | ±0.10 | .XX* | ±0.5* | | | DRAWG NO. | |
| UNITS | mm | APPD: DMX | | | | | |
| MATERILA | | CHED: TANG | | | | | |
| FINISH | | DRAW: SHI | | | | | |
| | | SCALE | | SHEET | | REV. | |
| | | 1:1 | | 1/1 | | A | |